

## DESIGN AND IMPLEMENTATION OF DIGITAL CONTROLLER IN DELTA DOMAIN FOR BUCK CONVERTER

Arka Biswas<sup>1</sup>, Arindam Mondal<sup>2</sup>, Prasanta Sarkar<sup>3</sup>

<sup>1</sup>Department of Aerospace Engineering, IIT Kharagpur, West Bengal, India

<sup>2</sup>Department of Electrical Engineering, Dr BC Roy Engineering College, Durgapur,  
West Bengal, India

<sup>3</sup>Department of Electrical Engineering, NITTTR Kolkata, West Bengal, India

**Abstract.** *This paper presents the design and implementation of a discrete-time controller for a DC-DC Buck converter in the complex delta domain. Whenever any continuous-time system is sampled to get a corresponding discrete-time system with a very high sampling rate, the shift operator parameterized discrete-time system fails to provide meaningful information. There is another discrete-time operator called delta operator. In the delta operator parameterized discrete-time system, the discrete-time results and continuous-time results can be obtained hand to hand, rather than in two special cases at a very high sampling rate. The superior property of the delta operator is capitalized in this paper to design the proposed controller in the discrete domain. The Proportional plus Integral (PI) controller designed in the delta domain is used to maintain the output voltage of the Buck converter at the load end for varying load and varying supply voltage conditions. The controller is designed and implemented using the DS1202 dSPACE board. The output voltage of the Buck converter is scaled to feed to the onboard analogue to digital converter of DS1202. Under the different disturbances, the error between the desired output voltage and the actual output voltage is measured and the delta PI controller is used to manipulate the duty cycle of the converter. The duty cycle of this pulse width modulation (PWM) signal is generated using a DS1202 board and is applied to the gate of the Metal Oxide Semiconductor field-effect transistor (MOSFET) via a suitable driver such that the output voltage of the Buck converter remains at its desired value.*

**Key words:** *Buck converter, delta domain, digital controller, dSPACE board, PI controller*

### 1. INTRODUCTION

The sources of conventional energy are decreasing day by day and the supply-demand gap is therefore increasing. This leads to a growing demand for non-conventional sources of energy. The output of most of the renewable sources is DC voltage and also, they are not stabilized. For the stabilization and conversion from one DC voltage level to another DC voltage level, one of the most important power-electronic circuits called the DC-DC converter, is used [1]. The maximum power point tracking is a very important area for

---

Received July 08, 2022; revised August 21, 2022; accepted September 01, 2022

**Corresponding author:** Arindam Mondal

Department of Electrical Engineering, Dr BC Roy Engineering College, Durgapur, West Bengal, India

E-mail: arininstru@gmail.com

maximization of solar power and is done through an electronic circuit consisting of a DC-DC converter [2]. There are two types of DC-DC converters available, one is the Buck converter, and another is the Boost converter. For the reduction of voltage level Buck converter is used. The Buck converter is widely used for the DC motor drive control [3], renewable systems [4], [5], [6] as it is one of the most interesting power electronics circuits which converts the uncontrollable DC input into controllable DC output. Whenever the supply voltage varies or the load is changed, there is a possibility of changing the output voltage of the Buck converter, thereby calling for a proper choice of controller [7]. In [8], Robust Adaptive Control (RAC) approach using system identification methodologies has been illustrated for controlling of Buck converter by PWM (Pulse width modulation) in the presence of input voltage as well as load variations. PID controllers are used for controlling the output voltage of the Buck converter [9] for low-power applications such as powering LED. As the Buck converter itself is a nonlinear system, the control effects of the system on voltage can be improved through the use of fractional-order PID controllers [10]. In [11], RCT digital robust control is used to overcome the instability issues caused by the negative resistance effect of constant power load. Nonlinear least squares optimization method-based digital controllers can be used for controlling the high-frequency Buck converter [12]. Through this approach, performance of the controller is optimized through the pole-zero-cancellation (PZC) technique and the adverse effects of the undesired poles on the Buck converter power stage are drastically reduced. A derivative-free Nelder-Mead (N-M) simplex method for designing a digital controller for buck converter operating in high frequency is depicted in [13] for the improvement of rise-time and settling time. The proportional-integral (PI) controller gives zero steady-state error and the simplest of all the controllers is generally used in different DC-DC converters [14]. Digital controllers are always better than analog controllers, therefore used for the controlling of DC-DC Buck converter. By using the digital control strategy, the algorithm or program can be easily altered. The digital PID controller can improve the performance of the Buck converter by varying loop gain, cross-over frequency and phase margin [15]. The control algorithm developed through the shift operator parameterization finds defects for high-frequency applications for Buck converter [16]. Digital controller design using the delta domain is better than the controller designed using the shift operator, particularly when the sampling rate is very high. The advantages and application of the delta operator in control theory are elaborated in [17], [18], and [19]. The delta operator has the diversified nature of giving results in the digital domain which is again equivalent to the continuous 's' domain, basically at high frequency. The discrete 'z' transfer function approximation turns out to be very sensitive even if there is a slight change in the values of the coefficient but the transfer function in the digital delta domain, progresses significantly the robustness of the estimate to parameter changes [20]. In [21], the delta operator is used to reduce the order of the model of a system which helped to save some extra bits in a digital system. The superior property of the delta ( $\delta$ ) operator is used in the case of fault detection and network control [22], for Kalman filter-based controller design used in cyber-physical systems [23]. To check the packet losses in the sensor to controller link or controller to actuator link, the delta operator is successfully applied for Lyapunov-Krasovskii functional design in the field of limited communication [24]. A delta domain-based PI controller is designed [25] for indirect field-oriented control (IFOC) for controlling an induction motor and the superiority of delta parameterised discrete-time system is proved. At a very high sampling frequency, the continuous-time results are the obvious outcome from discrete-time

measurements. The selection of sampling frequency is very much important during discretization. The sampling frequency must be 10 times the maximum frequency of the system to suitably reproduce the signal. For the design of PI controller in discrete shift operator parameterization sampling rate cannot be made high as it becomes numerically ill at very high sampling limit, therefore, for high frequency digitally controlled switching converters, delta domain PI controllers are most suitable [26]. The PI controller instead of the PID controller is used in the case of certain types of work where the voltage has a smaller amount of ripple during load change from lower load to higher load. This will cause the drop of the output voltage to develop smaller than the essential size and the same goes for the opposite, therefore, only the PI controller is sufficient for regulatory the process to be stable. The regulatory process using the PI controller is satisfactory as well as it has wide use in industries since it got a simple structure and is cost-efficient as compared to PID controller [27], [28]. For more precise results, a fractional-order controller can also be used instead of the traditional integer-order controller using the discrete delta operator [29]. For finding the parameters of fractional order controller in delta domain alpha guided grey wolf optimization technique can be used [30]. The DS 1202 dSPACE board is one kind of surrounded system where the controller can be designed and simulated using the Simulink and dSPACE block sets. The dSPACE has been successfully used for designing PID controllers for Buck and Boost converters [31], [32]. As the DS 1202 dSPACE board operates on the discrete-time platform, this can be used as a real-time controller for controlling the Buck converter for getting the output at desired level irrespective of the load and supply voltage variation.

The hardware implementation of the Buck converter along with the controller formulated in the delta domain using DS 1202 dSPACE board has been presented in this paper. The real-time analyses as well as simulation results are obtained using MATLAB/Simulink.

The significant contributions made in this paper are as given below:

In the earlier work, the digital controllers for buck converter have been designed using shift operator parameterization. The discrete-time systems so far designed are done using shift operator parameterization but shift operator parameterization fails to provide meaningful information at a high sampling rate. The real-time implementation of the controller in the digital domain needs a very high sampling rate to get a better result. This is the motivation to work on the implementation of a digital controller for buck converter using the delta operator parameterization. The most crucial part is that at a fast-sampling limit, the discrete domain results resemble that of the continuous-time results in the delta operator parameterized system.

Moreover, the discrete-time PI controller for buck converter, designed in the delta domain is implemented using the DS1202 dSPACE board which acts as the real-time controller with built-in ADC having a much higher resolution than any other microcontrollers. By using the realized controller, the output of the DC-DC buck converter provides a stable desired output voltage. Therefore, digital design and implementation of PI controller for Buck converter using delta operator parameterization is a newer concept and a new direction for further research.

This paper is organized in the following way. The basics of the Buck converter are discussed in section 2. In Section 3, the Control algorithm based on Delta-operator for DC-DC Buck Converter is described. The simulation and practical result analysis are illustrated in section 4. Finally, Section 5 is devoted to the conclusion.

## 2. BUCK CONVERTER

### 2.1. Topology

The Buck converter topology is used to step down the input voltage to a lower level. It consists of a power MOSFET switch, a filter inductor  $L$ , a filter capacitor  $C$ , a freewheeling diode  $D$  and a resistive load  $R_L$ . It operates either in continuous conduction mode or discontinuous conduction mode. Figure 1(a) represents the present topology of the Buck converter under consideration.

### 2.2. Operation

#### 2.2.1. Mode 1

When the gate pulse is applied to the MOSFET, current flows through  $L$ ,  $C$ , and  $R_L$  thus storing energy in the inductor. In this mode diode remains to reverse biased, the inductor current increases linearly and the load consumes energy from the source. Fig. 1(b) shows the equivalent circuit for the model when the switch is ON. The voltage and current equations during this mode are as follows:

$$e_L = L \frac{di}{dt} \quad (1)$$

where  $e_L$ , is the inductor voltage.

Let the inductor current increases from  $I_1$  to  $I_2$ , the Kirchoff's voltage equation is written as

$$E_{dc} - E_0 = L \left( \frac{I_2 - I_1}{T_{on}} \right) \quad (1)$$

where  $E_{dc}$  is the supply voltage,  $E_0$  is the output voltage and  $T_{on}$  is the on-time of the switch.

Peak to peak ripple current through the inductor  $L$  is defined as:

$$\Delta I = I_2 - I_1 \quad (2)$$

Equation (2) can be rewritten as

$$E_{dc} - E_0 = L \frac{\Delta I}{T_{on}} \quad (3)$$

#### 2.2.1. Mode 2

When the switch is off, the energy stored previously in the inductor acts as a source and current flows through  $C$ ,  $R_L$  and  $D$ . In this mode, the diode is in forward biased and conducts. Fig. 1(c) shows the equivalent circuit of mode 2 when the switch is off.

During  $T_{off}$ , the inductor current falls linearly from  $I_2$  to  $I_1$  and therefore the output voltage is expressed as

$$-E_0 = -L \frac{\Delta I}{T_{off}} \quad (4)$$

where  $T_{off}$ , is the off-time of the switch.

Comparing  $\Delta I$  from (3) and (4) and rearranging the variables, (5) is obtained.

$$E_0(T_{off} + T_{on}) = E_{dc}T_{on} \quad (5)$$

The time period is defined as  $T = T_{on} + T_{off}$ . Therefore equation (5) can be rewritten as

$$E_0T = E_{dc}T_{on} \quad (6)$$

Defining the duty ratio  $T_{on} / T$  as  $\alpha$ . The output equation can be expressed as

$$E_0 = \alpha E_{dc} \quad (7)$$

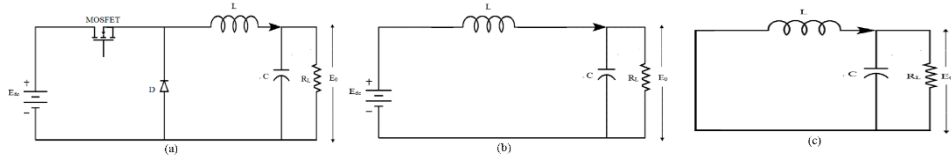

**Fig. 1** (a) An ideal Buck converter, (b) Mode 1: Switch on, (c) Mode 2: Switch off

The Buck Converter design parameters and the values of the components are detailed in Table 1

**Table 1** Buck Converter Design Parameter and Values

Parameter with Symbol	Value	Units
Input Voltage ( $E_{dc}$ )	8	Volt
Load Resistance ( $R_L$ )	100	k $\Omega$
Load Inductance ( $L_L$ )	100	H
Series Inductor ( $L$ )	100	$\mu$ H
ESR of Inductor ( $r_L$ )	10	m $\Omega$
Output Capacitor ( $C$ )	1000	$\mu$ F
ESR of Capacitor ( $r_c$ )	30	m $\Omega$
Forward Drop Across Diode ( $V_D$ )	0.7	Volt
ESR of Diode when Conducting ( $r_D$ )	0.01	$\Omega$
Drain-Source Resistance of MOSFET ( $r_T$ )	8	m $\Omega$
Operating Frequency	5	kHz

### 2.3. Choice of Sampling Rate

Though the Nyquist sampling theory recommends considering the sampling frequency as twice the maximum frequency contained in the signal. The thumb rule is that the minimum sampling frequency has to be 10 times the maximum frequency of the system. Therefore, the sample time will be  $1/10^{\text{th}}$  of the time constant. The transfer function of a Buck converter with  $V_o(s)$  as the output voltage and  $d(s)$  being the duty cycle is given below,

$$G_{Buck}(s) = \frac{V_o(s)}{d(s)} = \frac{\left(\frac{V_{in}}{LC}\right)}{s^2 + \frac{s}{RC} + \frac{1}{LC}} \quad (8)$$

The sampling time is related to the time constant, therefore before the sampling time is decided; the time constant has been calculated first. Considering the value of R and C are 100k and 1000uF respectively the time constant is coming out as 0.005 sec. According to the Nyquist theorem, the sampling time can be taken as 0.0005 sec or less. For the controller design in the delta domain, the sampling rate is considered as 0.00001 sec to study the behavior of the controller at a high sampling rate as well as to establish the philosophy of the proposed controller design in the delta domain.

### 3. THE CONTROL ALGORITHM BASED ON DELTA-OPERATOR FOR DC-DC BUCK CONVERTER

#### 3.1. Delta Operator

The  $d/dt$  operator in the continuous domain is well known for modelling any dynamic system. It is defined as

$$\frac{d}{dt} = \lim_{h \rightarrow 0} \frac{x_{(t+h)} - x_{(t)}}{h} \quad (9)$$

The urge for an operator which resembles this  $d/dt$  operator structurally as well as functionally in the discrete domain led to the development of the delta-operator ( $\delta$ ) which is defined as

$$\delta = \frac{x_{(n+\Delta)} - x_n}{\Delta} \quad (10)$$

where  $\Delta$  is the sampling time.

It is an incremental difference operator that works as a signal differentiator unlike signal shifting as the case with the shift operator. This is a shifted and scaled version of the shift operator. It can be shown easily that the response of the delta-operator converges with the  $d/dt$  operator of continuous-time as the sampling time tends to zero (0). This property can be understood by comparing the stable zone of continuous, shift and delta-operator in the frequency domain.

In the frequency domain, the  $d/dt$  operator is expressed by the Laplace operator  $S$  and the stable zone of this operator is widely known which is the entire left half side of the  $S$ -plane. In the frequency domain, the shift operator is denoted by  $Z$  and related to the Laplace operator  $S$  as

$$Z = e^{s\Delta} \quad (11)$$

Examining the positions of the poles, it is seen that the stable zone for the shift operator lies within a circle of radius 1 and the centre at the origin.

In the frequency domain, the delta operator is defined as

$$\gamma = \frac{Z-1}{\Delta} \quad (12)$$

Since it is a shifted and scaled version of the shift operator, the stable zone for the delta-operator is also get shifted and scaled. The stable zone of the delta operator lies in a circle of radius  $1/\Delta$  having the centre at  $(-1/\Delta, 0)$ . Fig.2 shows the stable zones of three domains. It can be observed that as the sampling time reduces, the stable zone of the delta-operator tends to converge with the stable zone of the continuous domain. Thus, the

use of the delta-operator provides a unified approach to model, design, analyse, and implement the digital control scheme.

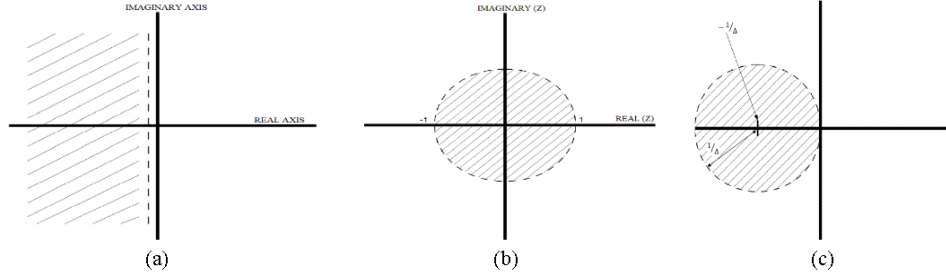

**Fig. 2** (a) Stability zone: S domain, (b) Stability zone: Z domain, (c) Stability zone:  $\delta$ -domain

### 3.2. The Digital Controller Design based on Delta-Operator

#### 3.2.1. PI Controller Design

To control the DC-DC Buck converter, a Proportional and Integral (PI) controller and a PWM generator are used. The PWM signal is required for the on/off operation of the MOSFET of the Buck converter. The PWM control technique is one of the popular control methods for any switching devices. In this experiment, the PWM signal is generated digitally to trigger the MOSFET of the circuit. The duty cycle of the PWM signal is controlled using the PI controller. The proposed PI controller is designed in the discrete delta domain and is simulated using MATLAB/Simulink before being implemented through the dSPACE.

The mathematical equations for a PI controller in continuous, shift and delta domain are as follows:

$$U(S) = \left( K_p + \frac{K_i}{S} \right) E(S) \quad (13)$$

$$U(Z) = \left( K_p + \frac{K_i}{1-Z^{-1}} \right) E(Z) \quad (14)$$

Since no  $\gamma^{-1}$  operator is available in MATLAB,  $Z^{-1}$  module is used to represent the  $\gamma^{-1}$ . The relation can be derived from equation (12) as:

$$\gamma^{-1} = \frac{\Delta Z^{-1}}{1-Z^{-1}}, \text{ therefore,} \quad (15)$$

$$U(\gamma) = \left( K_p + \frac{\Delta K_i Z^{-1}}{1-Z^{-1}} \right) E(\gamma)$$

where  $K_p$  and  $K_i$  are proportional gain and integral gain respectively.  $E$  is the error and  $U$  denotes the control signal. The representation of the  $\gamma^{-1}$  in SIMULINK is shown in Fig. 3.

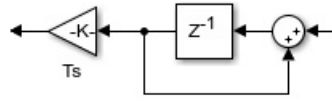

**Fig. 3** Representation of  $\gamma^{-1}$  in MATLAB SIMULINK

The transfer function of the PI controller in  $\delta$ -domain can be obtained from equation (14) by using equation (12). The simulations of the PI controller in the three stated domains are given in Fig. 4.

*3.2.2. Ziegler-Nichols Approach for Tuning of PI controller*

The Ziegler-Nichols approach for tuning industrial controllers is most well-known [33] and mostly favored by process control engineers in practice [34]. In this work, the Ziegler-Nichols approach is used to find out the PI controller parameters for Buck converter in the continuous time domain. The integral gain ( $K_i$ ) of the controller is set to zero and proportional gain is slowly increased till a sustained oscillation is observed. The value of proportional gain ( $K_p$ ) for which sustained oscillation received is called critical gain and denoted by  $K_C$ . The frequency of oscillations is measured and is called as critical frequency ( $f_c$ ). The values of  $K_p$  and  $K_i$  are tabulated as per the guidelines of Ziegler & Nicholos and given in Table 2.

**Table 2** Setting of PI Controller parameters using Ziegler-Nichols Rule

Controller	$K_p$	$K_i$
PI	$0.45 K_C$	$1.2 f_c$

The value of  $K_p$  and  $k_i$  are optimised through the guidelines of Ziegler-Nichols' chart. The optimised values of  $K_p$  and  $K_i$  obtained are 0.22 and 0.01 respectively.

The continuous time transfer function of PI controller is given by (16).

$$G_{PI}(S) = 0.22 + \frac{0.01}{S} \tag{16}$$

Corresponding  $\delta$ -domain transfer functions of the PI controller is expressed by (17) and the controller structure as given in (17) is realized using MATLAB/SIMULINK and dSPACE board for the implementation of PI controller in the delta domain.

$$G_{PI}(\gamma) = 0.22 + 0.005\Delta + 0.01\gamma^{-1} \tag{17}$$

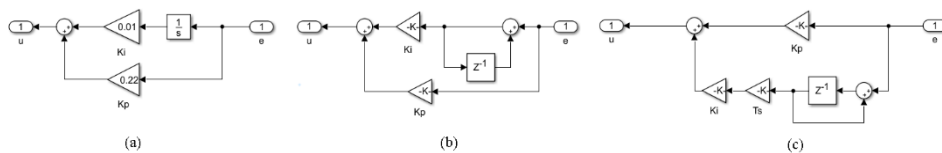

**Fig. 4** (a) PI Controller in the continuous domain, (b) PI Controller in the discrete Z domain, (c) PI Controller in the discrete  $\delta$  domain



3.2.3. Mechanism for Design of Digital Controller in Delta Domain

The complete mechanism for the design of the proposed PI controller for Buck converter in discrete delta domain is illustrated with a flowchart as shown in Fig. 5.

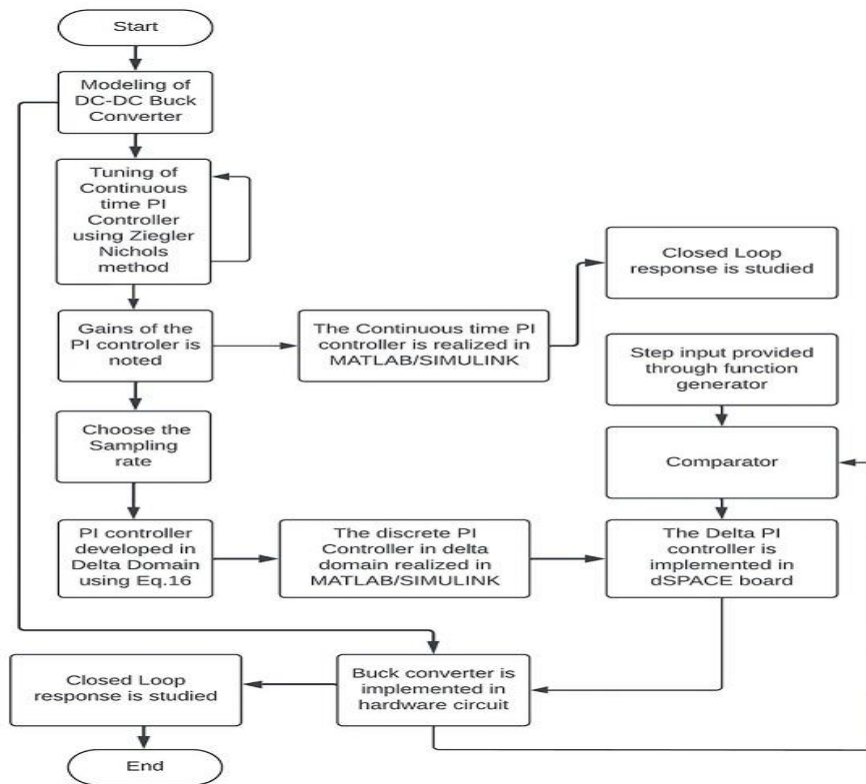

Fig. 5 Flowchart describing the complete mechanism of controller design in the delta domain

4. SIMULATION AND PRACTICAL RESULTS

Fig. 6 shows the schematic diagram of the proposed work.

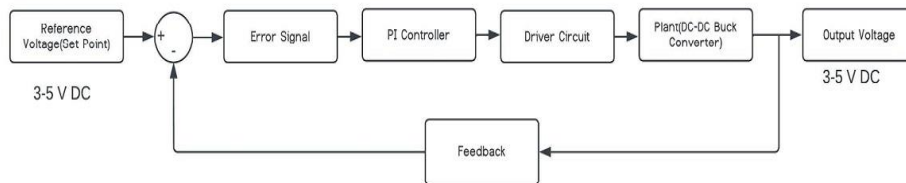
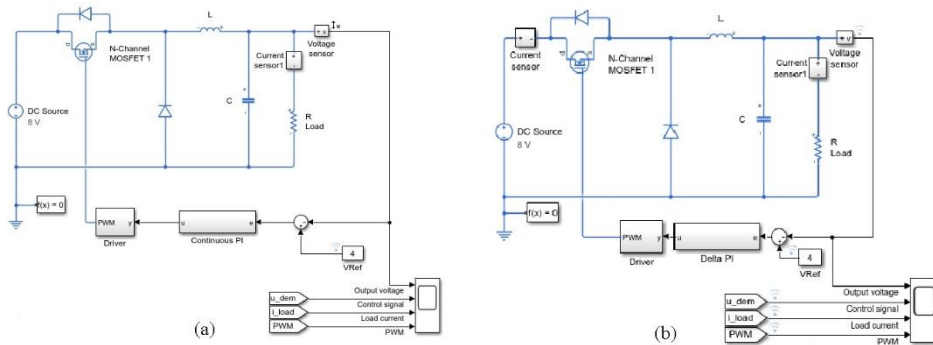

Fig. 6 Schematic diagram of the proposed method

#### 4.1. Simulation

The experiment has been simulated first using MATLAB/Simulink in SIM ELECTRONICS module. The simulation of closed-loop control of DC-DC Buck-converter using continuous-time PI controller and PI controller in delta domain along with the DC-DC Buck converter for R load has been depicted in Fig. 7.



**Fig. 7** Simulink model for closed-loop control of DC-DC Buck converter using (a) continuous-time PI controller with R load, (b) delta domain PI controller with R load

#### 4.2. Hardware Implementation

In this work, the controller used for the control action is built with the dSPACE Microlab board.

In the year 2000, at Bradley University, the dSPACE DS1102 was first used after developing the user's manual and a workstation based on this board. After that, a newer dSPACE DS1103 board has been developed. In this experiment, the latest version of dSPACE DS1202 has been used. The design and simulation of the controller are done using the MATLAB Simulink and the dSPACE block sets, the MATLAB-to-DSP interface libraries, Real-Time Interface to SIMULINK, and Real-Time Workshop on a PC. The output from the DS1202 includes the PWM signal to trigger the gate of MOSFET of the DC-DC Buck converter.

In this work, the dSPACE DS1202 system is used for the implementation of the control system; it is a mixed FPGA/DSP digital controller consisting of a powerful processor for the computation of floating-point. The PCI slot of the host computer is plugged with the key of DS1202. The control system is automatically processed and run in the DS1202 after being developed using MATLAB/Simulink.

A Graphical User Interface (GUI) has been built using dSPACE. It allows the real-time evaluation of the control system. The "control desk" is used for multiple services. It has the provision for interfacing using which, the controller model that has been designed in Simulink can be downloaded onto the DSP. Various measurements viz., the regulated output (voltage and current), the duty cycle of the PWM signal and error to the controller can be displayed at the instrument panel feature of the control desk.

The primary objective of using "DS1202" is as an interface between the external hardware portion of the overall system and the simulation. The DS1202 contains connectors for thirty-two (32) Analog-to-Digital inputs and sixteen (16) Digital-to-Analog outputs; there are forty-

eight (48) other connectors that can be used for Digital I/O, slave/DSP I/O, incremental encoder interfaces, CAN interface and serial interfaces.

The ADC that is used for feedback the output voltage is of 16 bits, i.e., it represents the values between 0 to 65535. Therefore, the resolution of ADC is  $(8/65535) V = 0.122$  mV. Now, the converter regulates the voltage to 4V which needs to be represented by 32765.5. But decimals cannot be represented due to the finite word length effect, so the reference voltage is represented by 32765. The ADC resolution error using dSPACE is much less compared to the ADC of 8 bit which is normally included in the Microcontroller. The inherent error is  $0.122/2 = 0.061$  mV in the reference voltage. The ADC resolution error can be small as 0.122 mV.

The PWM generator used here, is an in-built PWM generator that takes the control input as the duty ratio and generates a PWM signal accordingly at a given frequency. The amplitude of the PWM signal can be varied over the range of 2.5 V, 3.5 V, and 5 V. Fig. 8 shows the circuit implementation of Buck converter and Fig. 9 shows the simulated delta domain PI controller with dSPACE I/O blocks.

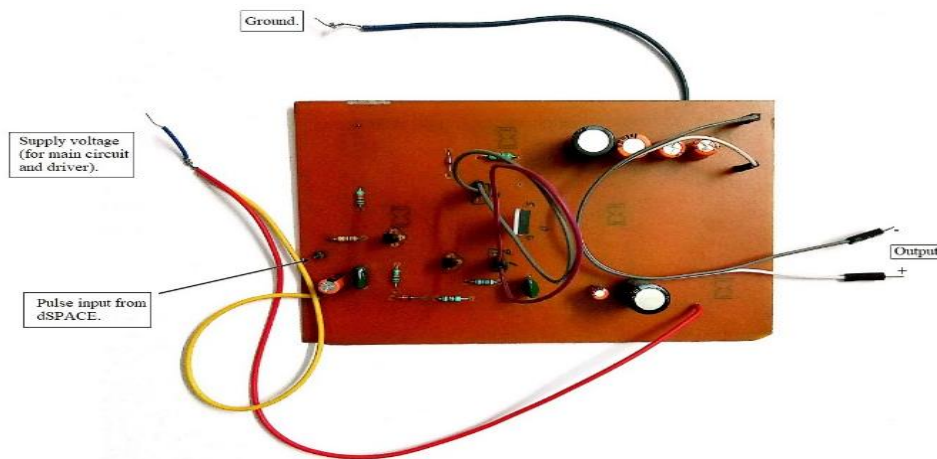

**Fig. 8** The circuit implementation of the DC-DC Buck converter

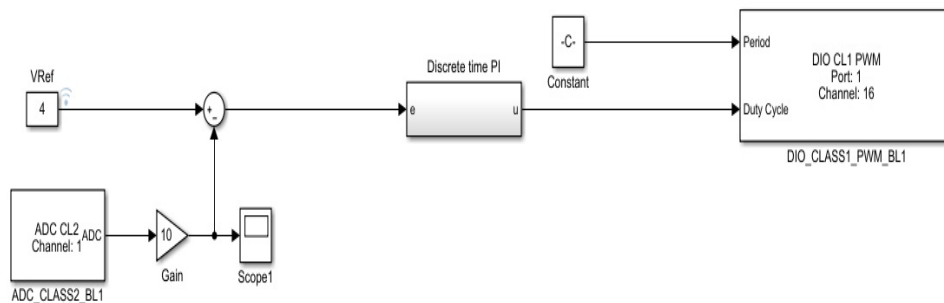
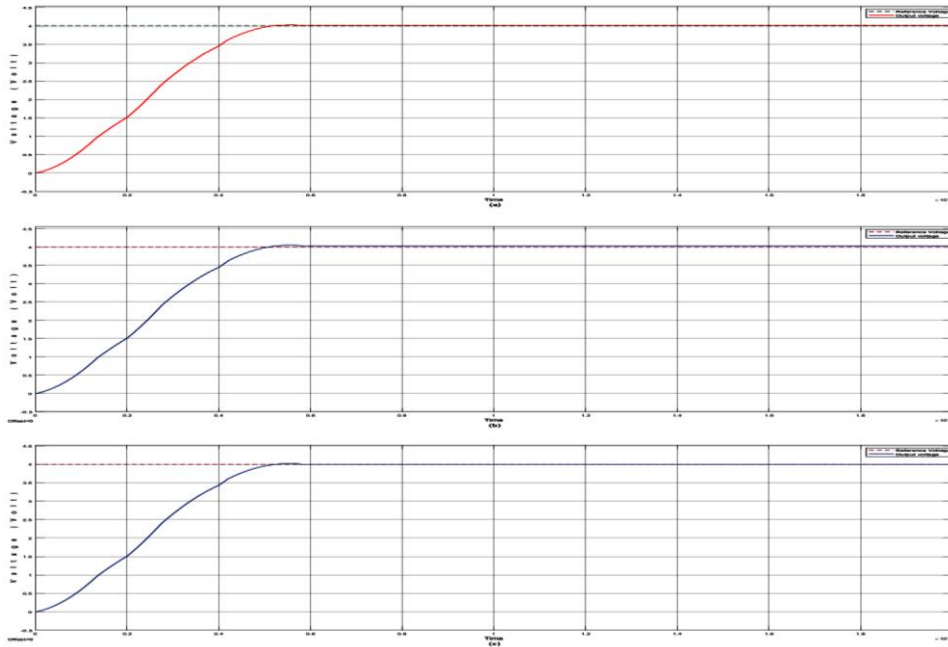

**Fig. 9** Discrete PI controller in the delta-domain with dSPACE RTI blocks

### 4.3. Result Analysis

#### 4.3.1. Simulation Result

Fig. 10 shows the response of the continuous-time PI controller and the response of the PI controller using the delta domain with low and high sample rates. The resemblance of the response of the PI controller designed in the delta domain at a high sampling rate is also shown here.



**Fig. 10** Simulation result with  $100\text{ k}\Omega$  resistance (a) Continuous domain PI controller response, (b) Delta domain PI controller response with a sample rate of 0.5 sec, (c) Delta domain PI controller response with a sample rate of 0.00001 sec

Fig. 11 shows the simulation result of the complete closed loop system under different load conditions. At first, the load is taken to be purely resistive and varied over the range of  $100\ \Omega$  to  $100\text{ k}\Omega$ . Subsequently, a  $100\text{ H}$  inductor is added to test the behaviour of the system under inductive load. In each case, the controller output remains at a steady desired output voltage of  $4\text{ V}$ .

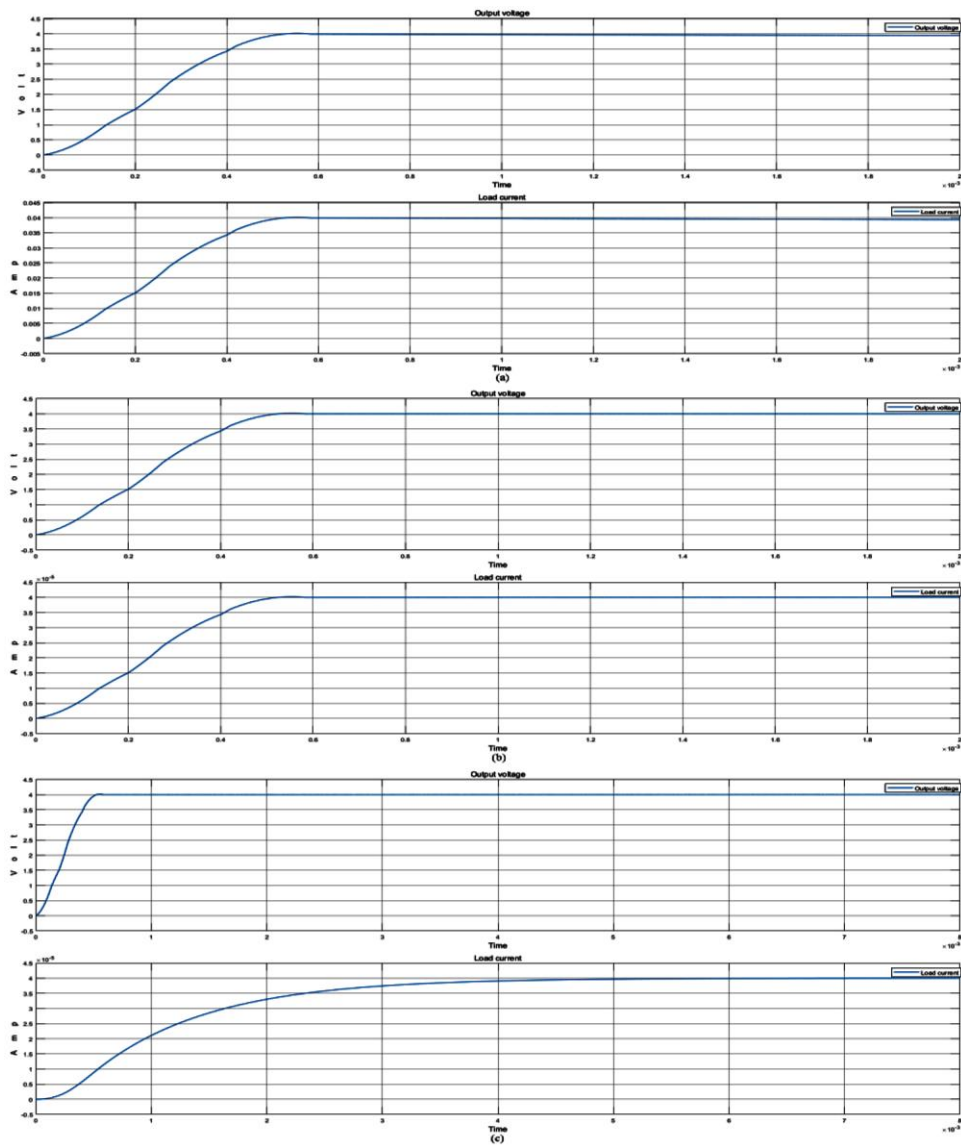

**Fig. 11** Simulation of the system under different load conditions. (a) with 100  $\Omega$  resistance, (b) with 100 k $\Omega$  resistance, (c) with R-L load consisting of 100 k $\Omega$  resistance and 100 H inductor

In each case, the current variation is shown with the variation of the load. The output voltage regulation of the Buck converter with the load variation is thus depicted in terms of current variation in Fig. 11.

#### 4.4. Real-Time Experimental Results

Fig. 12 shows the complete hardware setup with Microlab dSpace board, designed Buck converter, CPU and DSO.



**Fig. 12** Complete hardware setup with 4 volts as reference

The load is varied over the ranges from  $100\ \Omega$  and  $100\ \text{k}\Omega$ . With the variation of load resistances, the output of the Buck converter is set at almost 4 V at its output which is the desired set point. The variation of the output with the changes in load resistances is depicted in Figure 13. The output of the Buck converter at a load resistance of  $100\ \Omega$  is shown in Figure 13(a) whereas, Figure 13(b) is used to illustrate the changes in output voltage with a load resistance of  $100\ \text{k}\Omega$ . Therefore, it is evident that the controller is successfully working for the output voltage regulation of the buck converter for load variation.

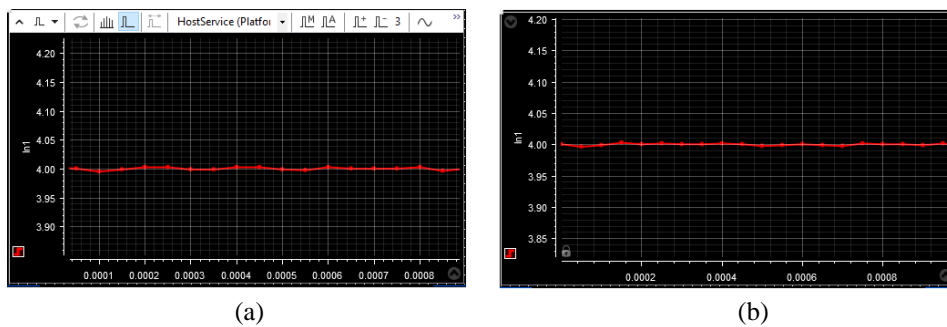

**Fig. 13** Regulation of output voltage for load resistance of (a)  $100\ \Omega$  (b) for  $100\ \text{k}\Omega$

The system is also tested with the variation of source voltages keeping the set point fixed at 4 Volt. In Fig. 14, output voltage regulation for a variety of source voltages like 6V, 8 V and 20 V is depicted. It is observed that with the different input voltage levels, the output of the Buck converter is stable at the desired set point which is 4.0 V in this experiment. Thus, the controller is working efficiently to maintain its output level fixed even if there are any changes in the source voltages.

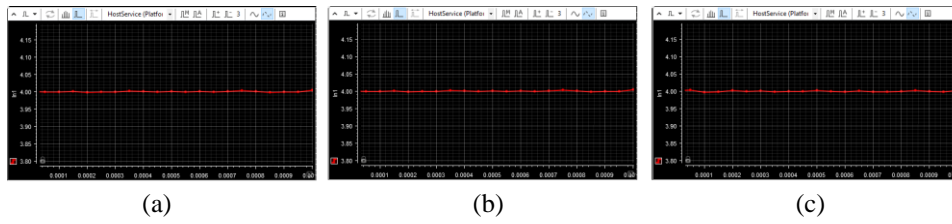

**Fig. 14** Regulation of output voltage with the variation of the source voltages of (a) 6 Volt, (b) 8 Volt, (c) 20 Volt

PWM signal with different duty cycles are generated through the dSPACE board and are shown in Fig. 15. The PWM signal is varied with the changes of the reference voltages.

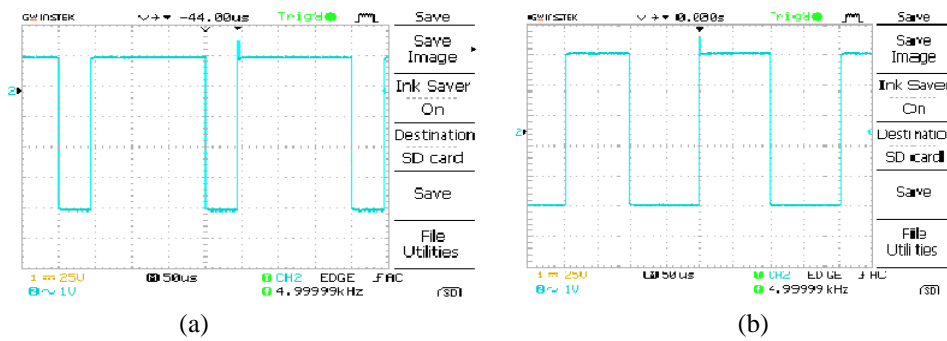

**Fig. 15** PWM Signal fed to the Buck converter at (a) 75% duty cycle, (b) 50% duty cycle

## 5. CONCLUSION

The work in this paper deals with the development of the digital PI controller in the delta domain and its implementation in DS1202 dSPACE board for the DC-DC Buck converter. The mathematical analysis, simulations and experiments are conducted using a PI-compensated Buck converter. It is found that the performance of the chosen DC-DC Buck converter is satisfactory under variation of supply voltage as well as load. The output voltage changes are only 0.25% when the load and supply voltage are varied as can be shown in Fig. 11, Fig. 13 and Fig. 14 respectively. By varying the duty cycle of PWM using the designed controller in dSPACE, the output voltage is adjusted proportionately as shown in Fig. 15. From the simulation result as given in Fig. 10, it is found that the sampling time ( $\Delta$ ) is reduced up to 0.00001sec and desired result is obtained which is again almost same as that of the output obtained by using the continuous-time controller. From this result, it is proved that at a fast sampling limit the delta parameterised system provides meaningful information. The mathematical derivations, simulations, and experiments performed in this paper conclude that the delta operator parameterized discrete-time controller's exhibit certain numerical advantages and at a high sampling rate the results of the continuous-time controllers are almost same as the results obtained by using the controller designed in delta domain. This leads to the development of a unified approach for digital controller design for Buck converter using the delta operator.

## REFERENCES

- [1] N. Mohan, T. M. Undeland, & W. P. Robbins, *Power Electronics: Converters, Applications, and Design*, John Wiley & Sons, New York, 2002.
- [2] G. Dileep & S. N. Singh, "Selection of non-isolated DC-DC converters for solar photo voltaic system", *Renewable Sustainable Energy Review*, vol. 76, pp. 1230-1247, 2017.
- [3] A. Bhaumik, Y. Kumar, S. Srivastava, & M. Islam, 2016, "Performance studies of a separately excited DC motor speed control fed by a buck converter using optimized PI $\lambda$ D $\mu$  controller", In Proceedings of the Int. Conf. Circuit, Power Comput. Technol. (ICCPCT), Nagercoil, India, 2016.
- [4] M. Hassanaliyagh, T. Soyata, A. Nadeau, & G. Sharma, "UR-SolarCap: An open-source intelligent auto-wakeup solar energy harvesting system for supercapacitor-based energy buffering", *IEEE Access*, vol. 4, pp. 542-557, 2016.
- [5] Q. Xu, C. Zhang, C. Wen, & P. Wang, "A novel composite nonlinear controller for stabilization of constant power load in DC microgrid, *IEEE Trans. Smart Grid*", vol.10, no. 1, pp. 752-761, 2010.
- [6] D. Kumar, F. Zare, & A. Ghosh, "DC microgrid technology: System architectures, AC grid interfaces, grounding schemes, power quality, communication networks, applications, and standardizations aspects", *IEEE Access*, vol. 5, pp. 12230-12256, 2017.
- [7] Liu Qingpeng, Research on Buck converter based on linear feedback control [D], Northeast Petroleum University, 2012.
- [8] M. Ghamari, H. Mollaei, F. Khavari, "Robust self-tuning regressive adaptive controller design for a DC-DC BUCK converter", *Measurement*, vol. 174, 109071, 2021.
- [9] C. Deekshitha & K. Latha Shenoy, "Design and Simulation of Synchronous Buck Converter for LED Application", In Proceedings of the 2nd IEEE International Conference on Recent Trends In Electronics Information & Communication Technology, Bangalore, India, 2017, pp. 142-146.
- [10] Z. Yichen, X. Hejin & L. Deming, "Feedback control of fractional PI $\lambda$ D $\mu$  for DC/DC Buck converters", In Proceedings of the International Conference on Industrial Informatics -Computing Technology, Intelligent Technology, Industrial Information Integration, Wuhan, China, 2017, pp. 219-222.
- [11] A. M. AbdurRaqueeb, A. A. AL-Shamma'a, A. Alkhuhyali, A. M. Noman, K.E. Addoweesh, "RST Digital Robust Control for DC/DC Buck Converter Feeding Constant Power Load", *Mathematics*, vol. 10, id. 1782, p. 15, 2022.
- [12] G. Abbas, J. Gu, U. Farooq, M. Irfan Abid, A. Raza, M. Asad, V. E. Balas and M. E. Balas, "Optimized Digital Controllers for Switching-Mode DC-DC Step-Down Converter", *Electronics*, vol. 7, no. 12, id. 412, p. 25, 2018.
- [13] G. Abbas, M. Nazeer, V. Balas, T.-C. Lin, M. Balas, M. Asad, A. Raza, M. Shehzad, U. Farooq and J. Gu, "Derivative-Free Direct Search Optimization Method for Enhancing Performance of Analytical Design Approach-Based Digital Controller for Switching Regulator", *Energies*, vol. 12, no. 11, id. 2183, p. 18, 2019.
- [14] K. R. Kumar & S. Jeevanathan, "Design of Sliding Mode Control for Negative Output Elementary Super Lift Luo Converter operated in Continuous Conduction Mode", In proceedings of the Communication Control and Computing Technologies (ICCCCT), Ramanthapuram, India, 2010. pp. 138-148.
- [15] K. Sharma & D. K. Palwalia, 2017, "Design of Digital PID Controller for Voltage ModeControl of DC-DC Converters", In Proceedings of the International conference on Microelectronic Devices, Circuits and Systems (ICMDCS), Vellore, India, 2017.
- [16] L. H. Guang, W. Bo & L. G. You, 2005, "Delta Operator Control and its Robust Control Theory Basis (M), National Defence Industry Press, Beijing.
- [17] R. H. Middleton & G. C. Goodwin, 1990, *Digital Control and Estimation-A Unified Approach*, Prentice-Hall, Englewood Cliffs. New Jersey.
- [18] R. H. Middleton & G. C. Goodwin, 1986, "Improved finite wordlength characteristics in digital control using delta operators", *IEEE Transactions on Automatic Control*, vol. 31, no. 11, pp. 1015-1021.
- [19] J. Cortes-Romero, A. Iuviana-Juarez & H. Sira-Ramirez, 2013, "A Delta Operator Approach for the Discrete-Time Active Disturbance Rejection Control on Induction Motors", *Mathematical Problems in Engineering*, vol. 2013, id. 572026, p. 9, 2013.
- [20] G. Maione, "High-Speed Digital Realisation of Fractional Operators in Delta Domain", *IEEE Transactions on Automatic Control*, vol. 56, no. 3, pp. 697-702, 2011.
- [21] S. Ganguli, G. Kaur & P. Sarkar, "A hybrid intelligent technique for model order reduction in the delta domain: a unified approach", *Springer Nature, Soft Computing*, vol. 23, pp. 4801-4814, 2018.
- [22] Y. Zhao & D. Zhang, "H $\infty$  Fault Detection for Uncertain Delta Operator Systems with Packet Dropout and Limited Communication", In Proceedings of the American Control Conference, Seattle, WA, USA, 2017, pp. 4772-4777.
- [23] J. Gao, S. Chai, M. Shuai, B. Zhang & L. Cui, "Detecting False Data Injection attack on cyber-physical system based on Delta Operator", In Proceedings of the 37th Chinese Control Conference, Wuhan China, 2018.



- [24] J. Zhou, D. Zhang, *IEEE Access*, Multidisciplinary, vol. 7, id. 94448, 2019.
- [25] A. Mondal, P. Sarkar, A. Hazra, "A unified approach for PI controller design in delta domain for indirect field-oriented control of induction motor drive", *Journal of Engineering Research*, vol. 8, no. 3, pp. 118-134, 2020.
- [26] B. L. Eidson, 2010, An Experimental Evaluation of Delta Operator in Digital Control, Auburn, Alabama.
- [27] I. Laoprom, S. Tunyasirut, "Design of PI Controller for Voltage Controller of Four-Phase Interleaved Boost Converter Using Particle Swarm Optimization", *Journal of Control Science and Engineering*, id. 9515160, p. 13, 2020.
- [28] K. S. Rao, R. Mishra, "Comparative study of P, PI and PID controller for speed control of VSI-fed induction motor", *International Journal of Engineering Development and Research*, vol. 2, no. 2, pp. 2740-2744, 2014.
- [29] L. A. Quezada-Téllez, L. Franco-Pérez, "Guillermo Fernandez-Anaya, 2020, Controlling Chaos for a Fractional-Order Discrete System", *IEEE Open Journal of Circuit and Systems*, vol. 1, pp. 263-269, 2020.
- [30] P. Hu, S. Chen, H. Huang, G. Zhang, L. Liu, "Improved alpha-guided grey wolf optimizer", *IEEE Access*, vol. 7, pp. 5421-5437, 2018.
- [31] T. S. Anandhi, K. Muthukumar & S.P. Natarajan, "dSPACE Based Implementation of PID Controller for Buck Converter", In Proceedings of the dSPACE User Conference, 2012.
- [32] V. R. R. G, K. K. B & A. K. G, "dSPACE Based 12/24v Closed Loop Boost Converter for Low Power Applications", In Proceedings of the International conference on computation of power, energy, information and communication, Chennai, India, 2014, pp. 213-217.
- [33] Ogata, K. *Modern Control System*, 1987, University of Minnesota, Prentice Hall.
- [34] N Pillai, P.A. Govender, Particle Swarm Optimization approach for model independent tuning of PID control loop, IEEE Africon, IEEE Catalog: 04CH37590C, 2007.